

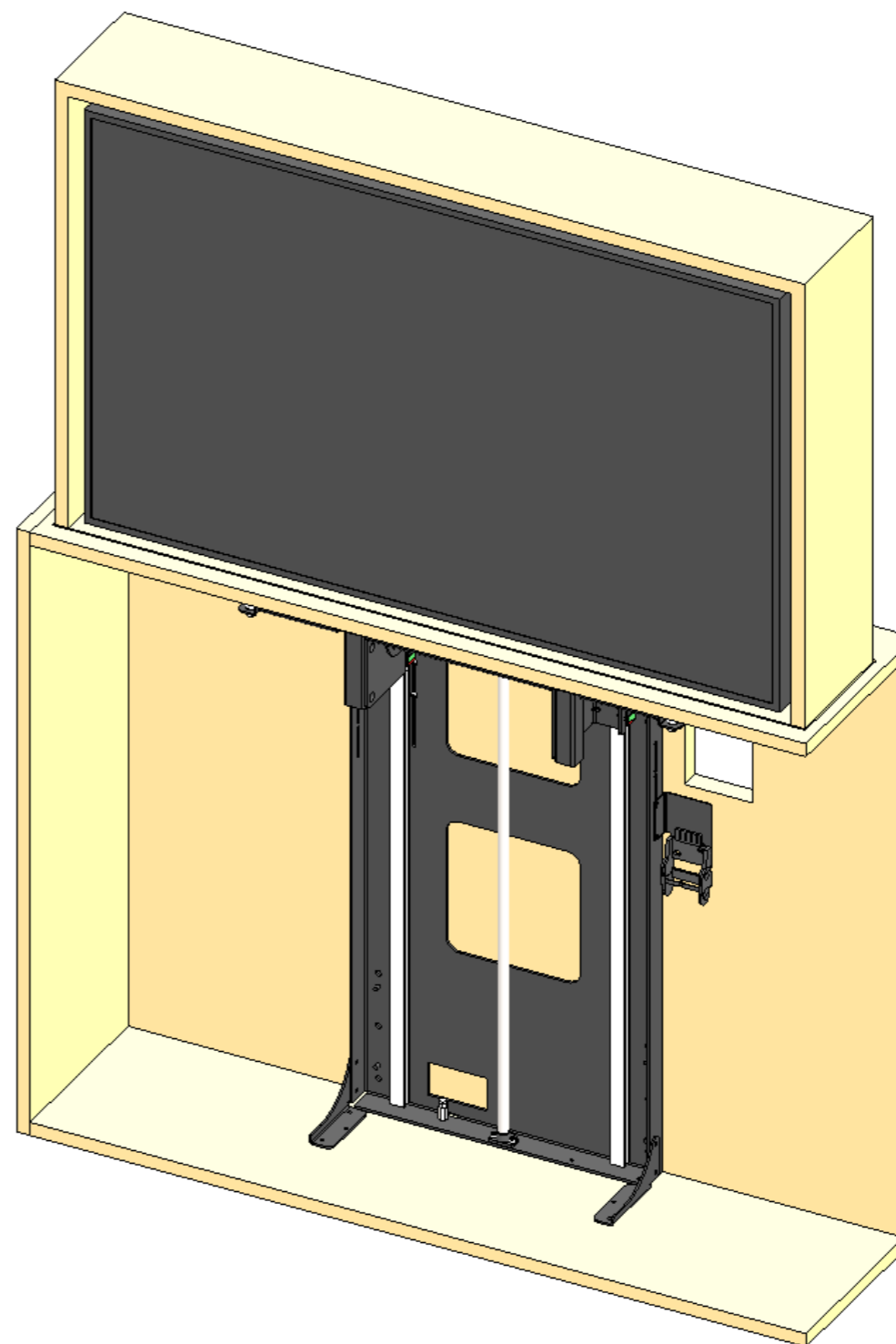

DESIGN HIGHLIGHTS

- Quiet smooth lifting action at approximately 40mm [1.6] per second
- Full cable management
- Wide range of mounting options
- 24V DC motor. Suitable for direct DC supply
- Marine suitable robust beam

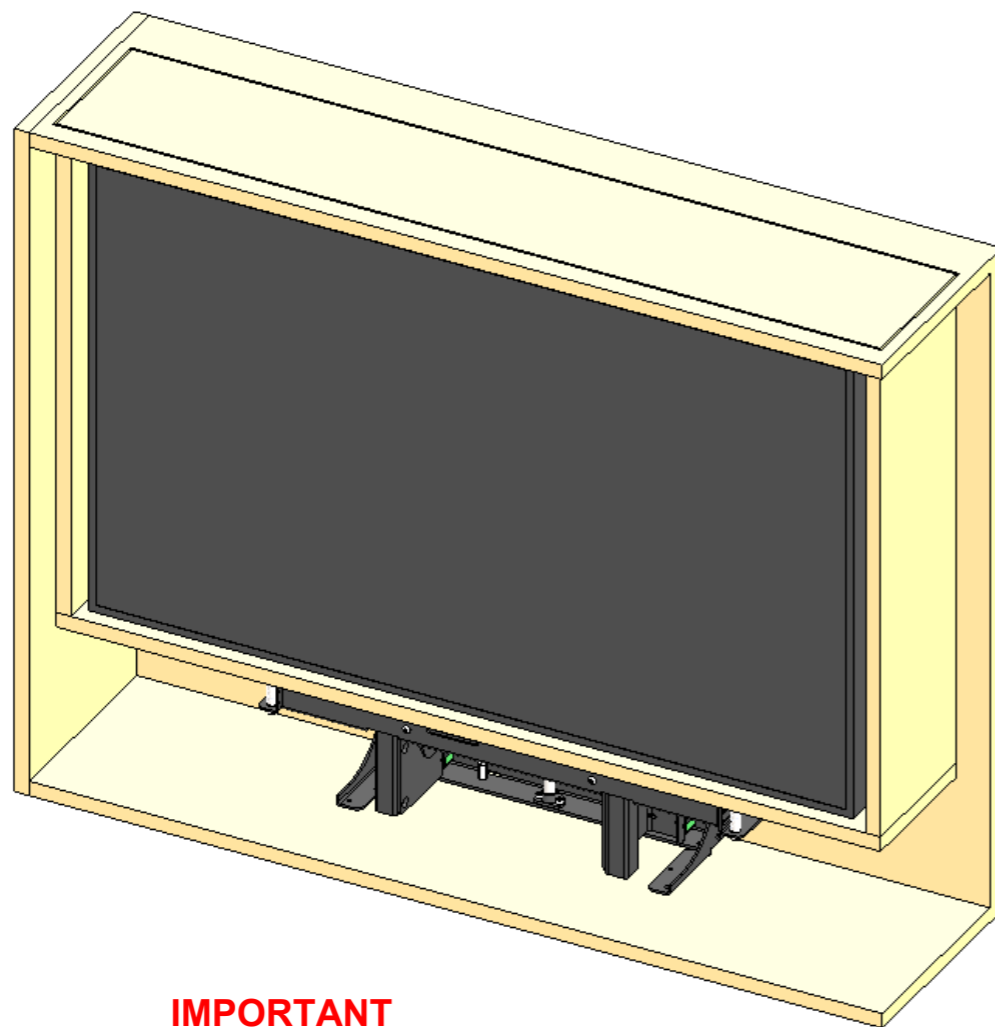

FUNCTION

An electric mechanism to lift two televisions that are mounted back to back. Suitable for marine use. Shown here for use with an enclosed screen.

SUITABILITY

Suitable for a total lifting weight of 80Kg [176lbs] or 40Kg [88lbs] in a marine environment. This is the weight of the screens and the screen enclosure that is made by others. The enclosure can easily make up 10Kg [22lbs] of the total capacity.

Maximum screen height 700mm [27.5]

Maximum Screen Depth 70mm [2.7]

Lift systems to suit different screen heights are available

SPECIFYING

Check screen mounting details and check for screen connectors that may add to screen depth.

CONTROL

Supplied with basic infrared remote. Can be learnt by many learning remotes.

Also has switch control and RS232 so can be operated by relays, switches, Crestron / AMX or Lutron systems.

WARNING

It is the responsibility of the installer to warn all potential end users of the dangers of interfering with mechanisms during operation

IMPORTANT

Mechanisms which lift or move weights need to be checked on a yearly basis for any damage which may result in an accident

Design Highlights

A space efficient and robust lifting mechanism, suitable for use in marine environments.

The Back to Back Screen Mounting System allows two screens to be easily installed and removed from the Screen Enclosure.

The Screen Enclosure gives the product a neat finish, concealing all screen connections.

A robust 24V DC motor with a purpose made lead screw enables a quiet and smooth lifting action at approximately 40mm [1.6] per second.

High precision linear guideways ensure stability and durability of the beam to prevent any unwanted movement of the screen.

Adjustable UP and DOWN positions allow for a precise final setup within the cabinet.

The safety switched base reduces the risk of damage to the mechanism or injury to the user by cutting power to the motor when there is an obstruction between the cabinet and base panel.

Full cable management protects all screen and power cables from damage and is easily accessible for future changes to the AV setup.

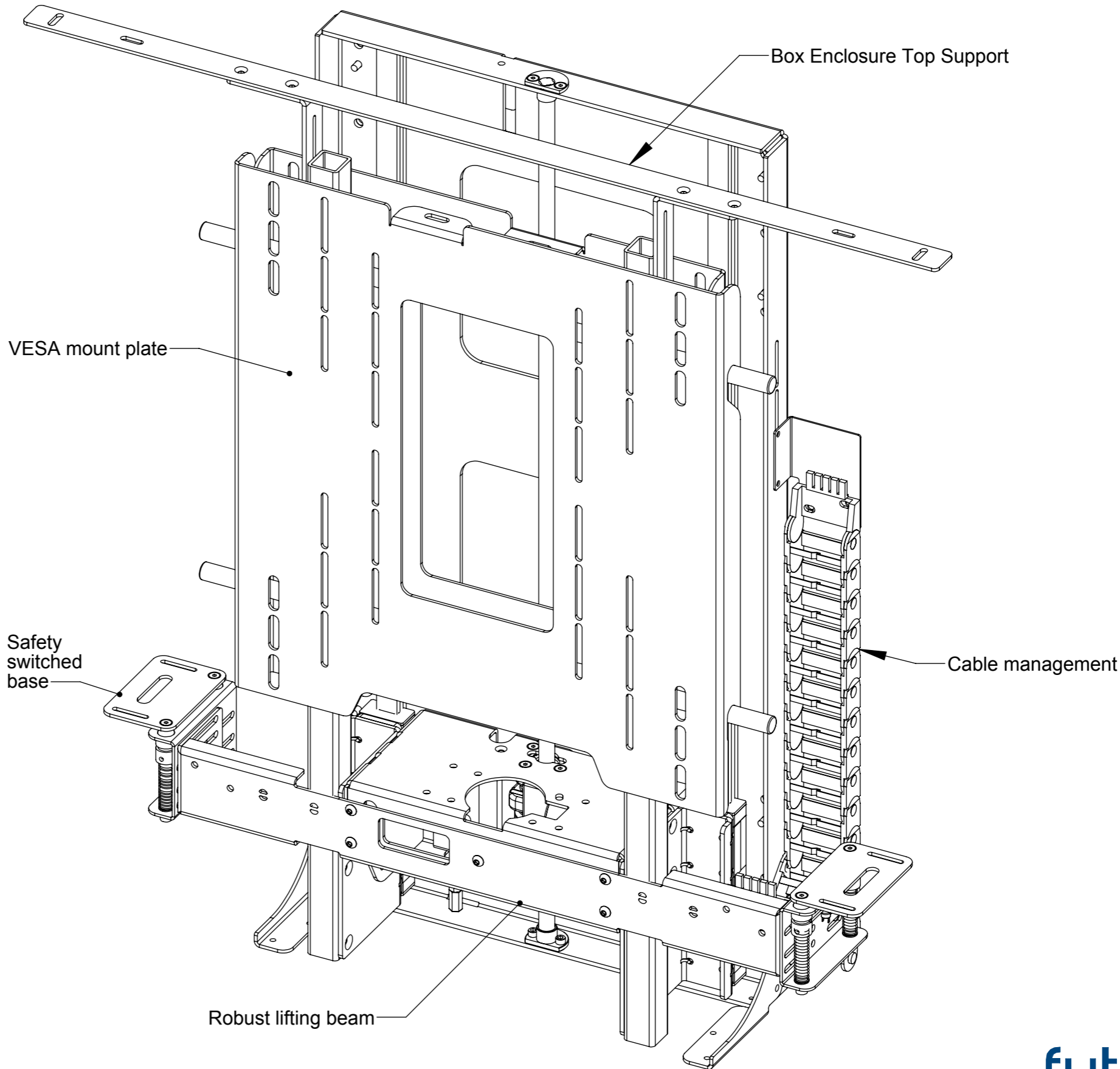

Cable Routing

The Screen Enclosure Base Panel must have an opening in the centre for screen cables to travel through. Cables are routed through the lifting beam and into a cable management track. Cables must be routed carefully to prevent any interference with the mechanism as it operates.

Screen and Mechanism cables should be routed to a control box outside of the cabinet via an opening in the back of the cabinet or a conduit leading to the bottom.

- - - - - SCREEN CABLE
- - - - - MECHANISM CABLE
- - - - - POWER CABLE

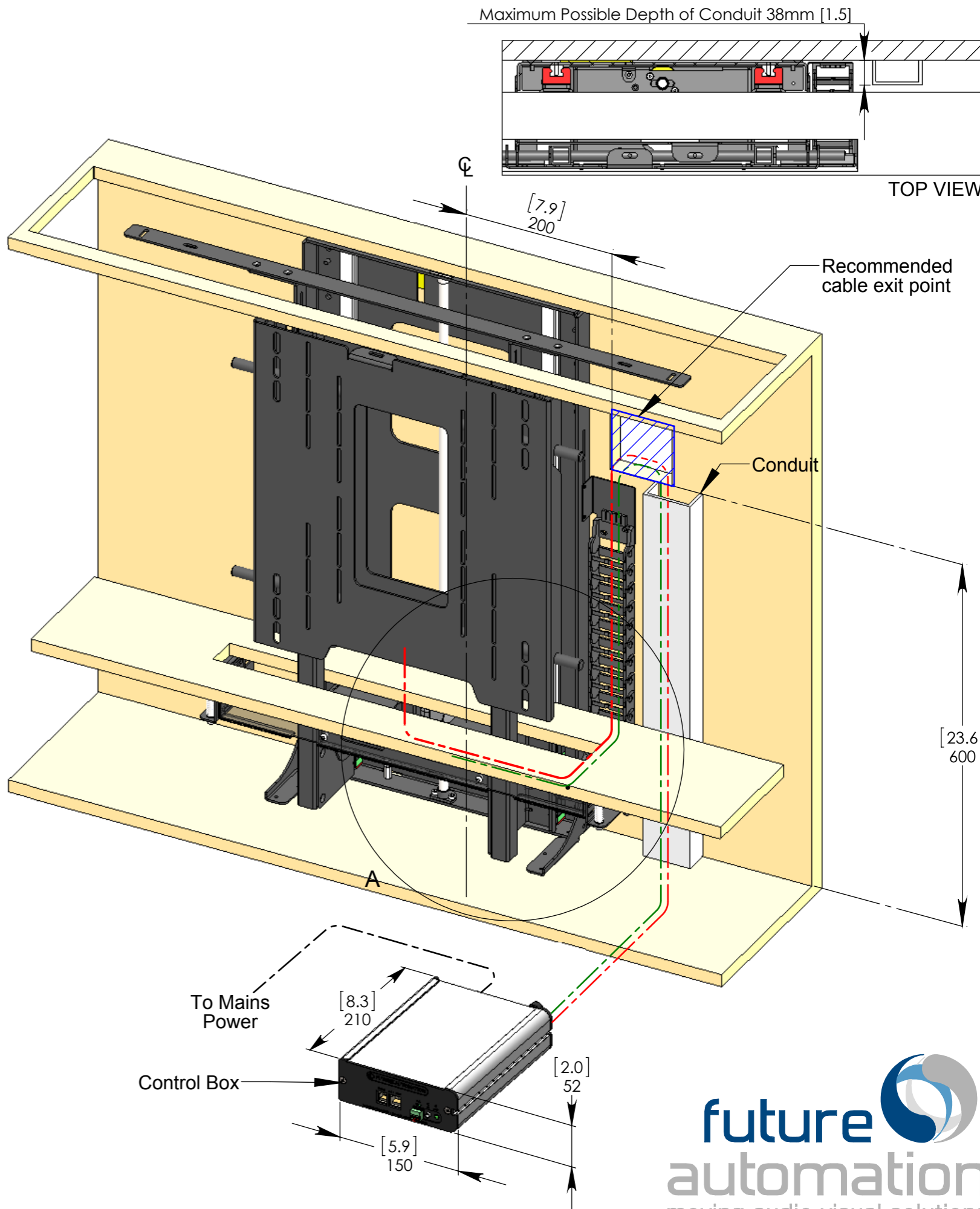
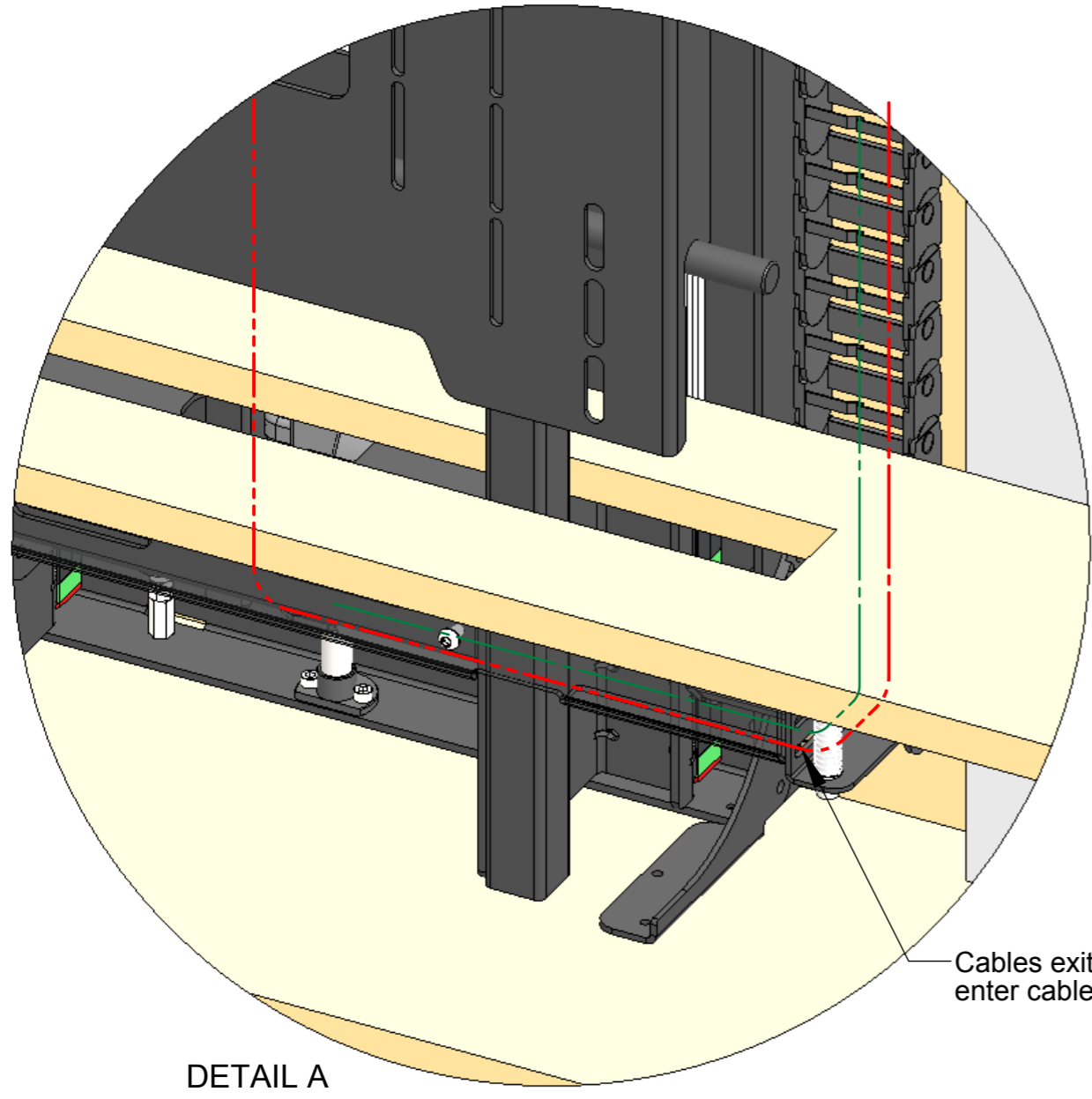

Mechanism Up - In Cabinet

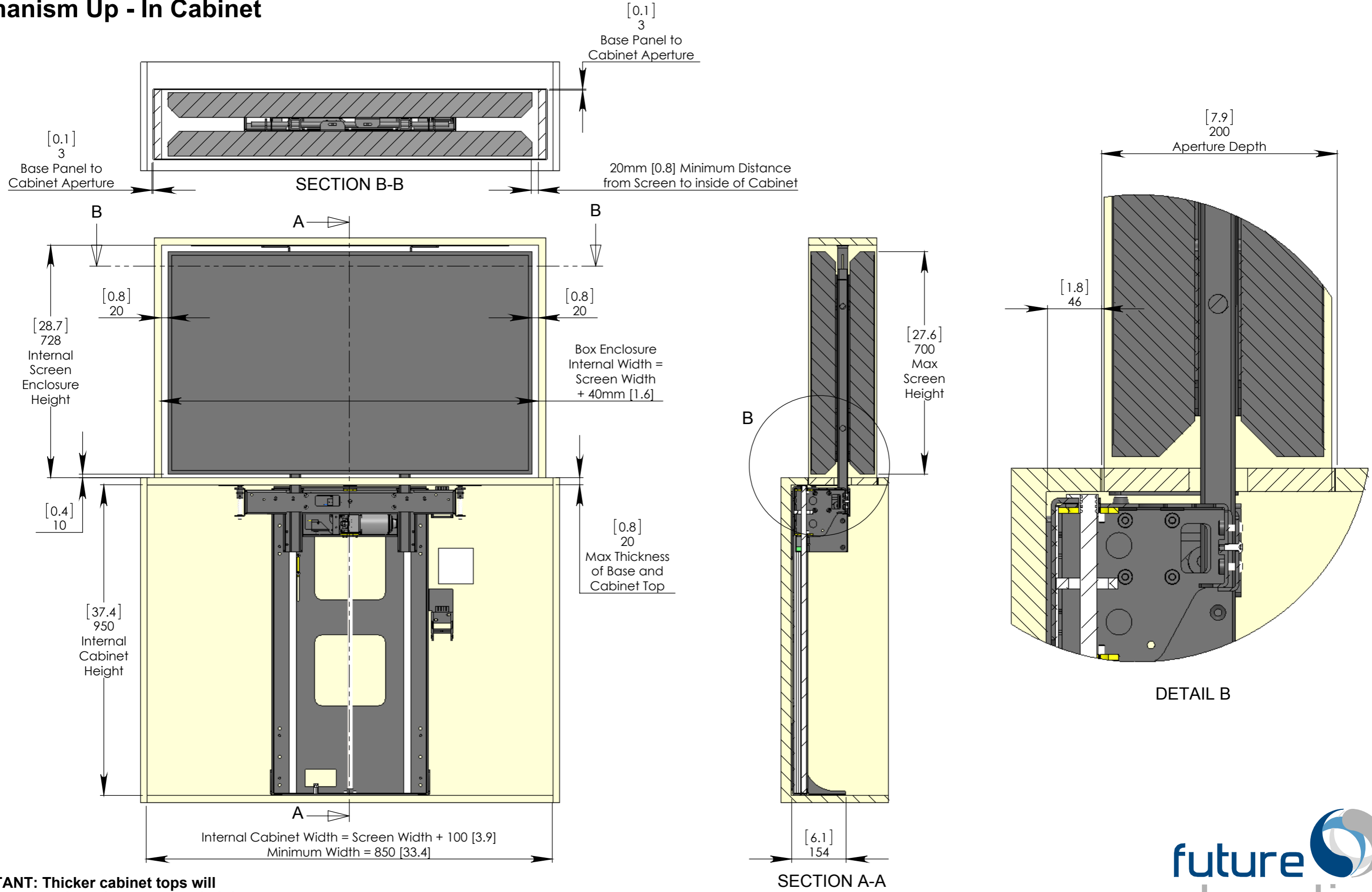

IMPORTANT: Thicker cabinet tops will require a reduced maximum screen height

Mechanism Down - In Cabinet

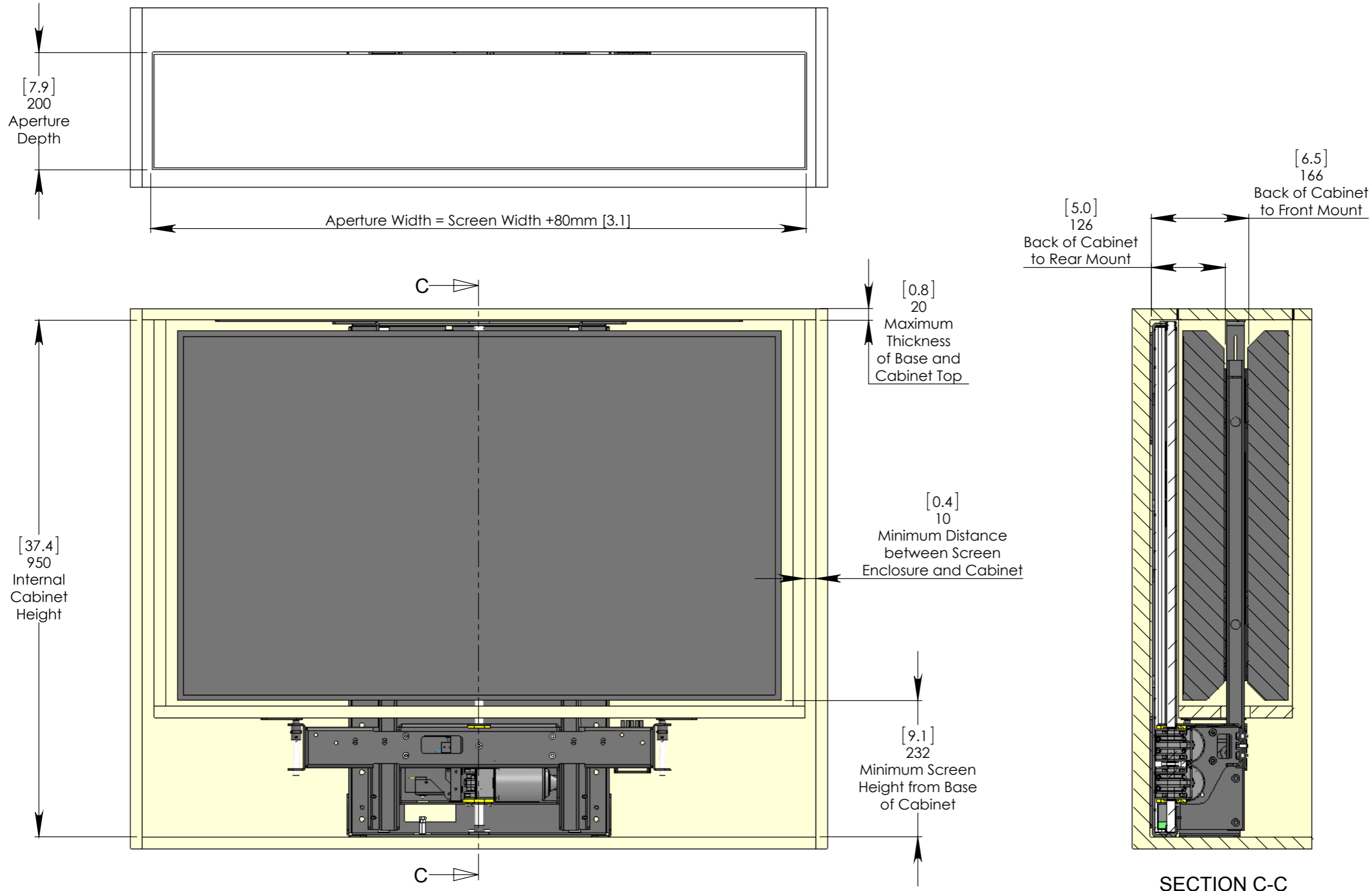

IMPORTANT: Thicker cabinet tops will require a reduced maximum screen height

Base Panel and Box Enclosure Lid Details

BOX ENCLOSURE LID - TOP VIEW

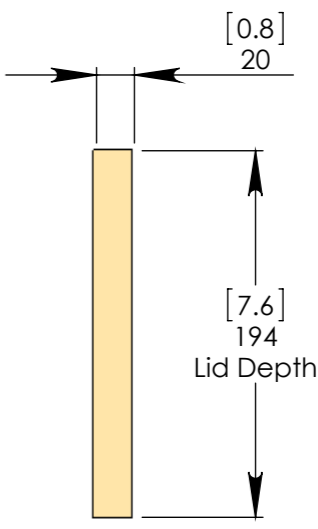
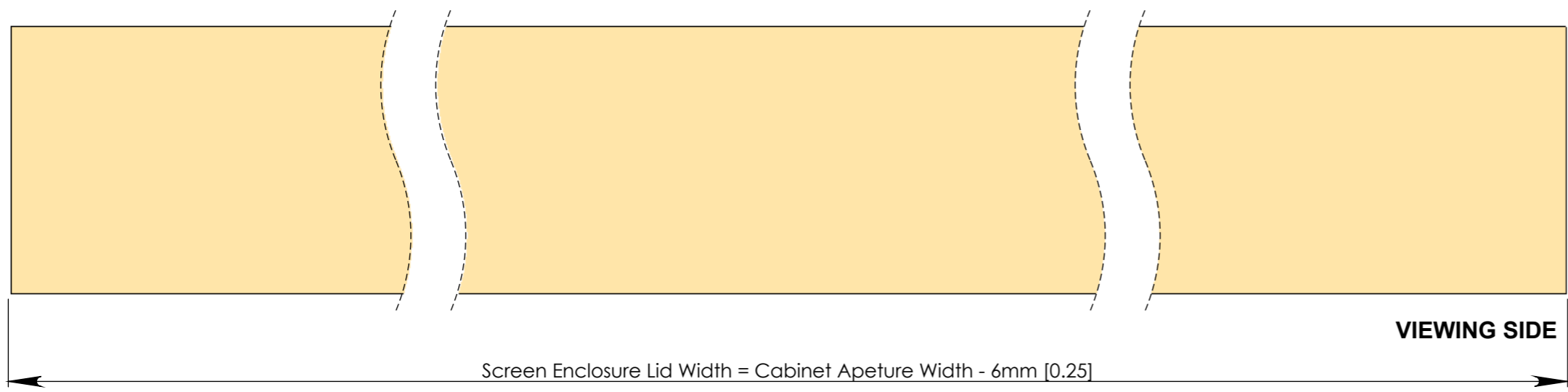

BASE PANEL - TOP VIEW

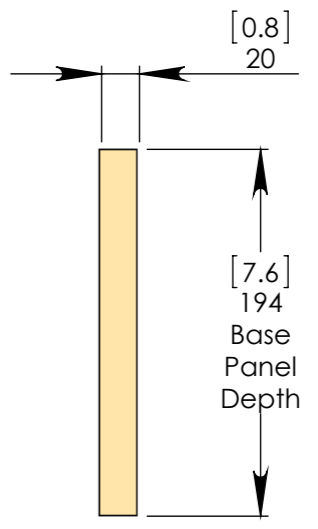
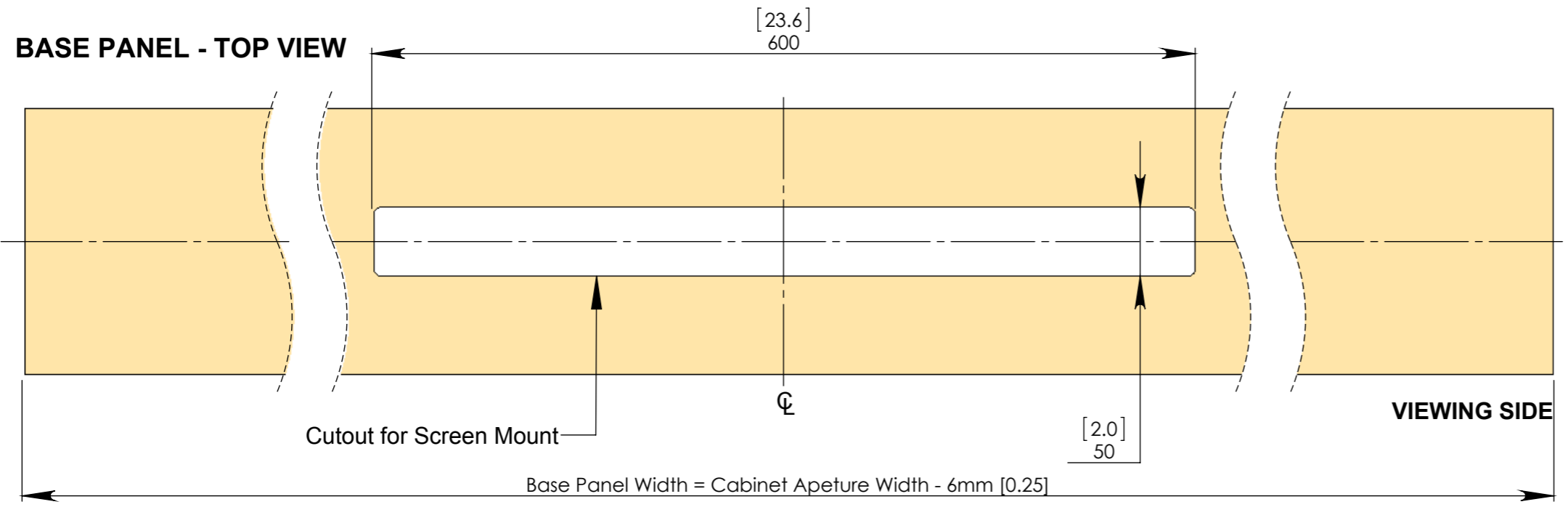

Screen Mount Adjustability

A standard VESA 400 mount is included. This is also compatible with VESA 300 and 200 mounting patterns.

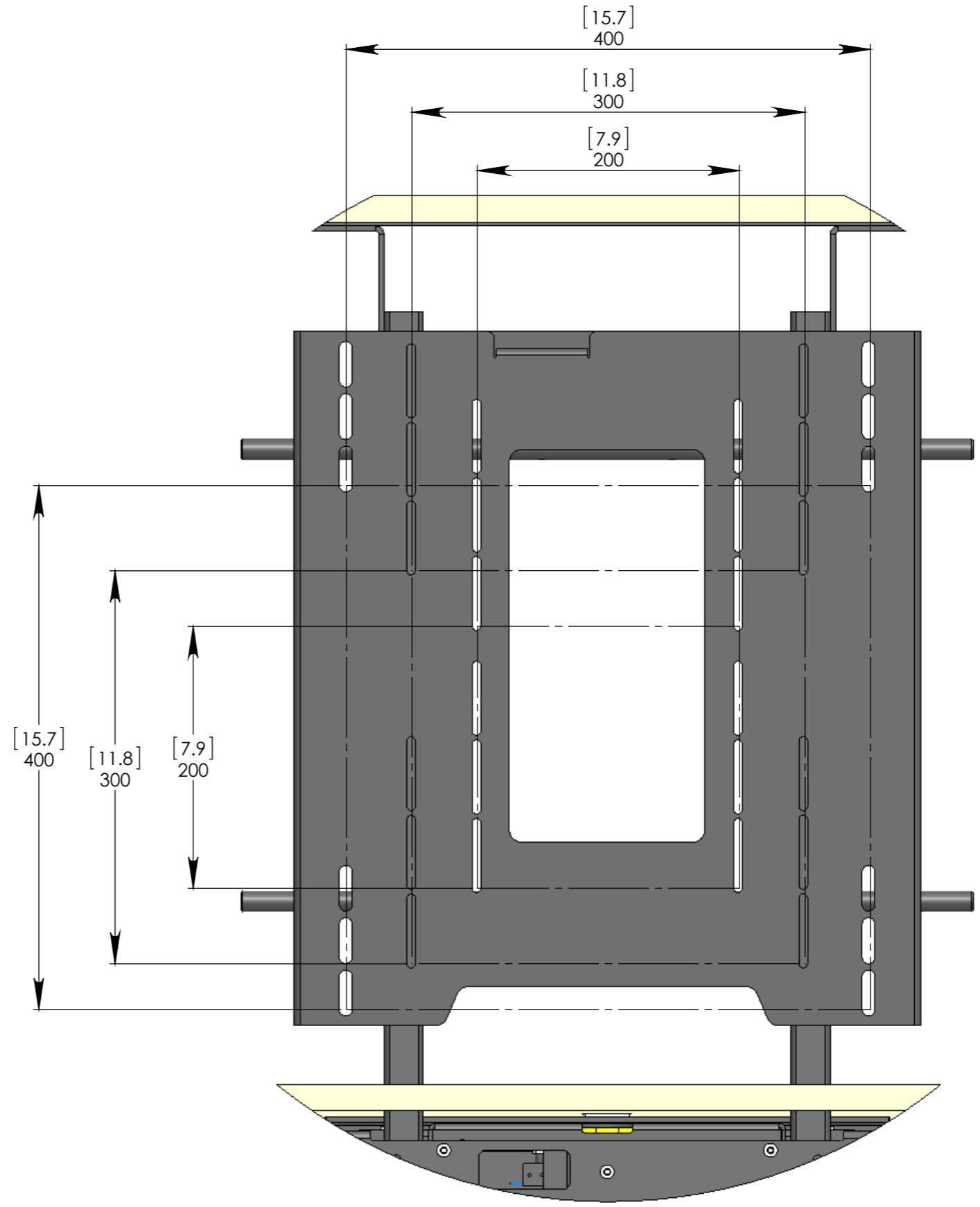
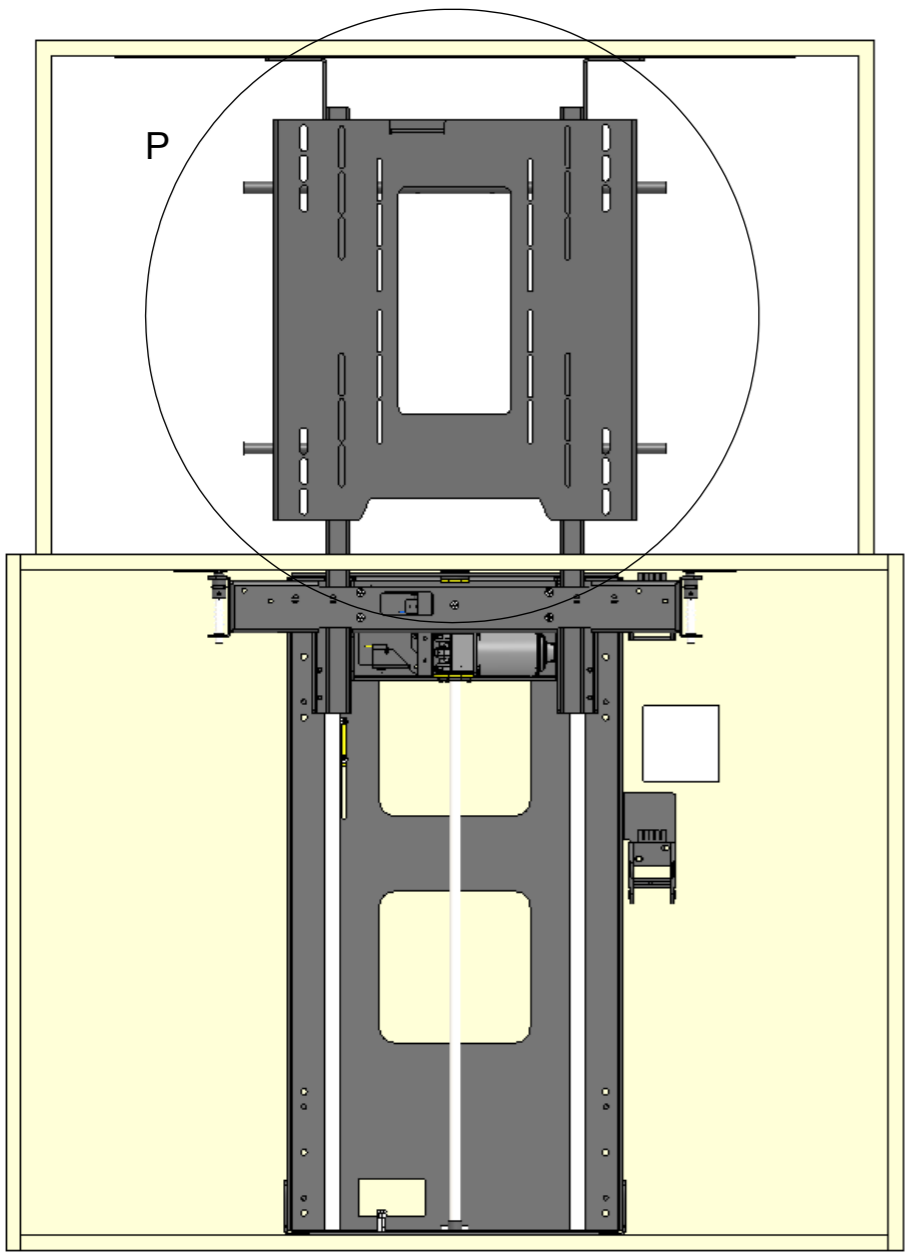

DETAIL P

Mechanism Installation Overview

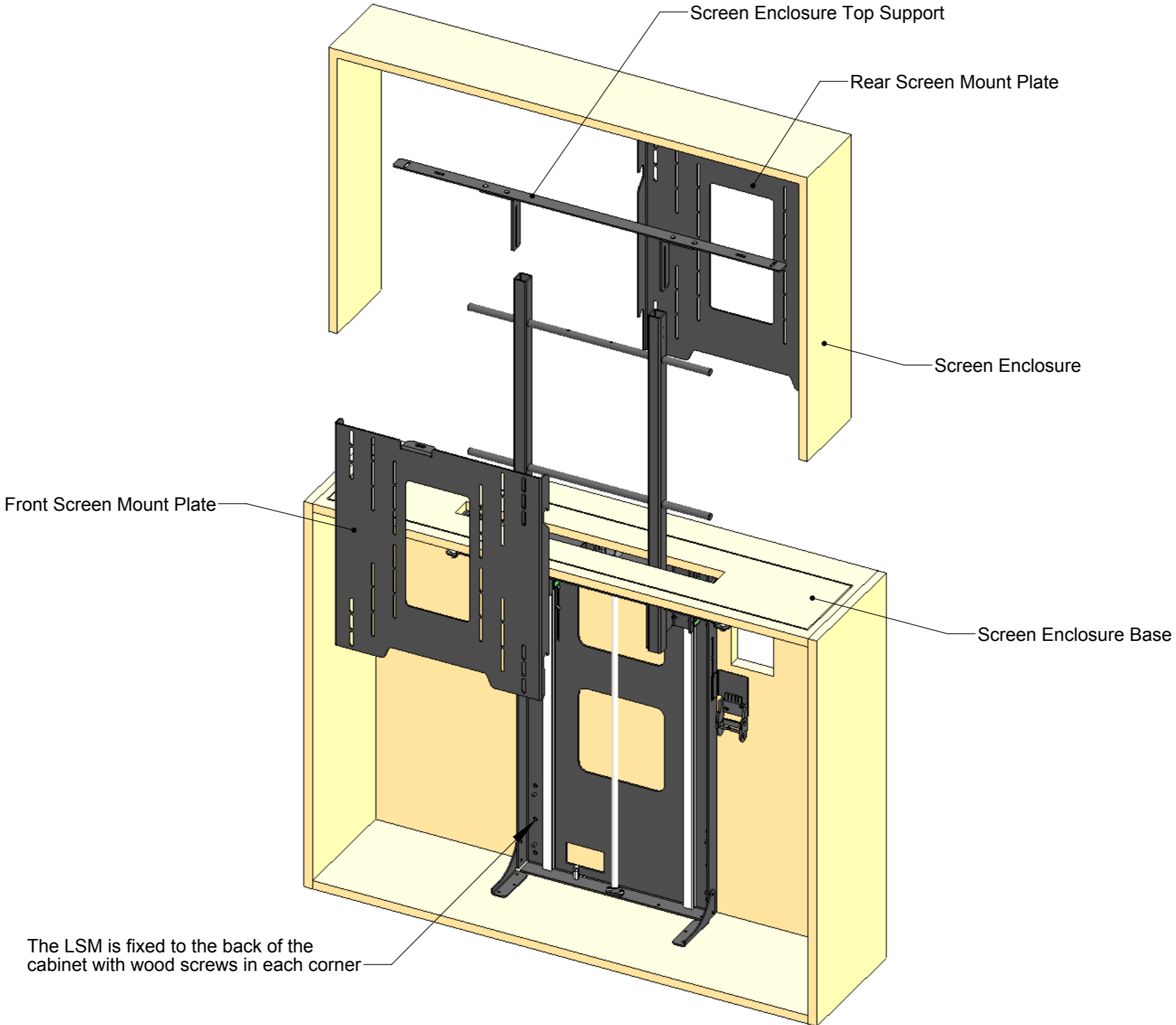

Overall Mechanism Dimensions

MECHANISM - UP POSITION

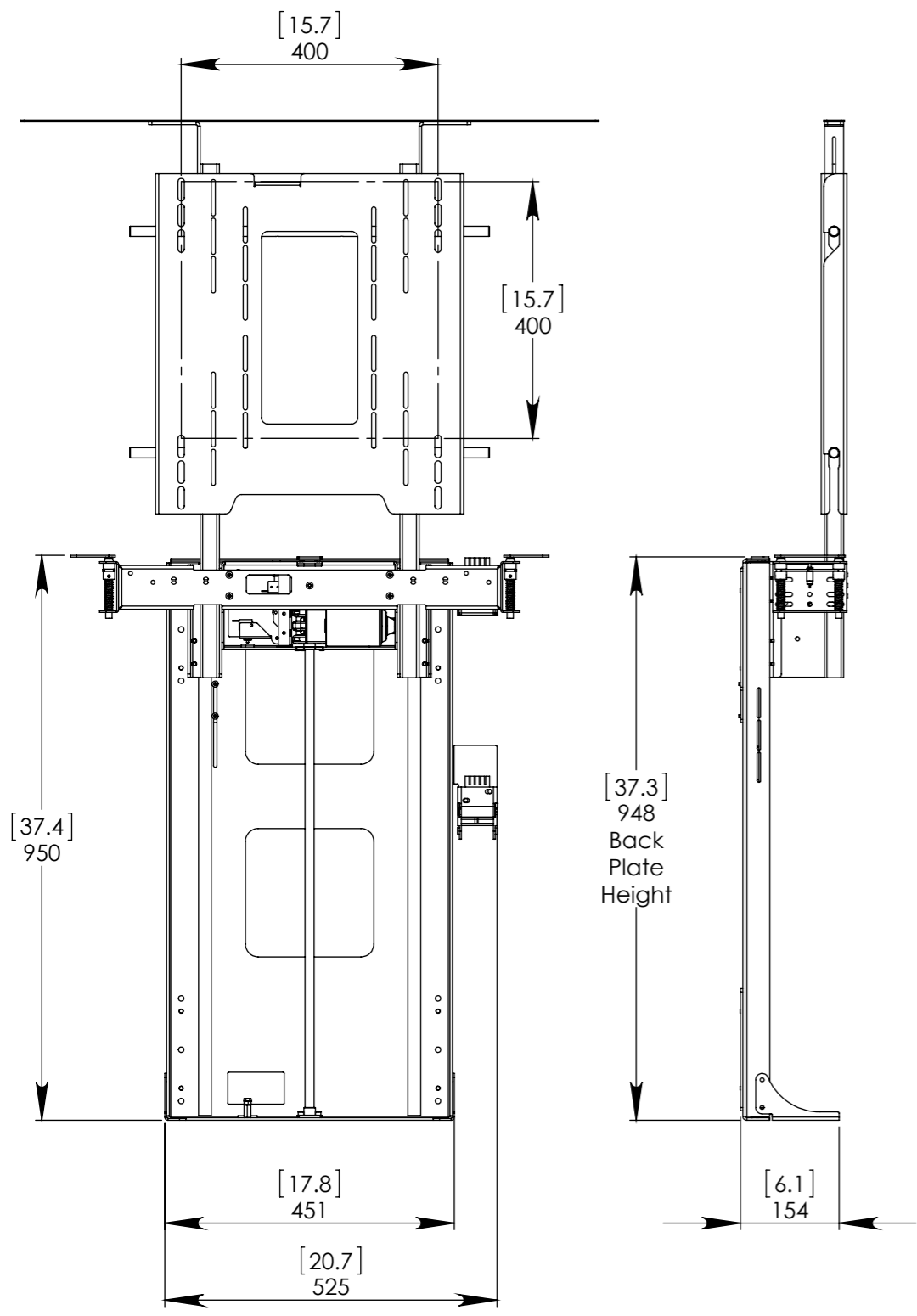

MECHANISM - DOWN POSITION

